

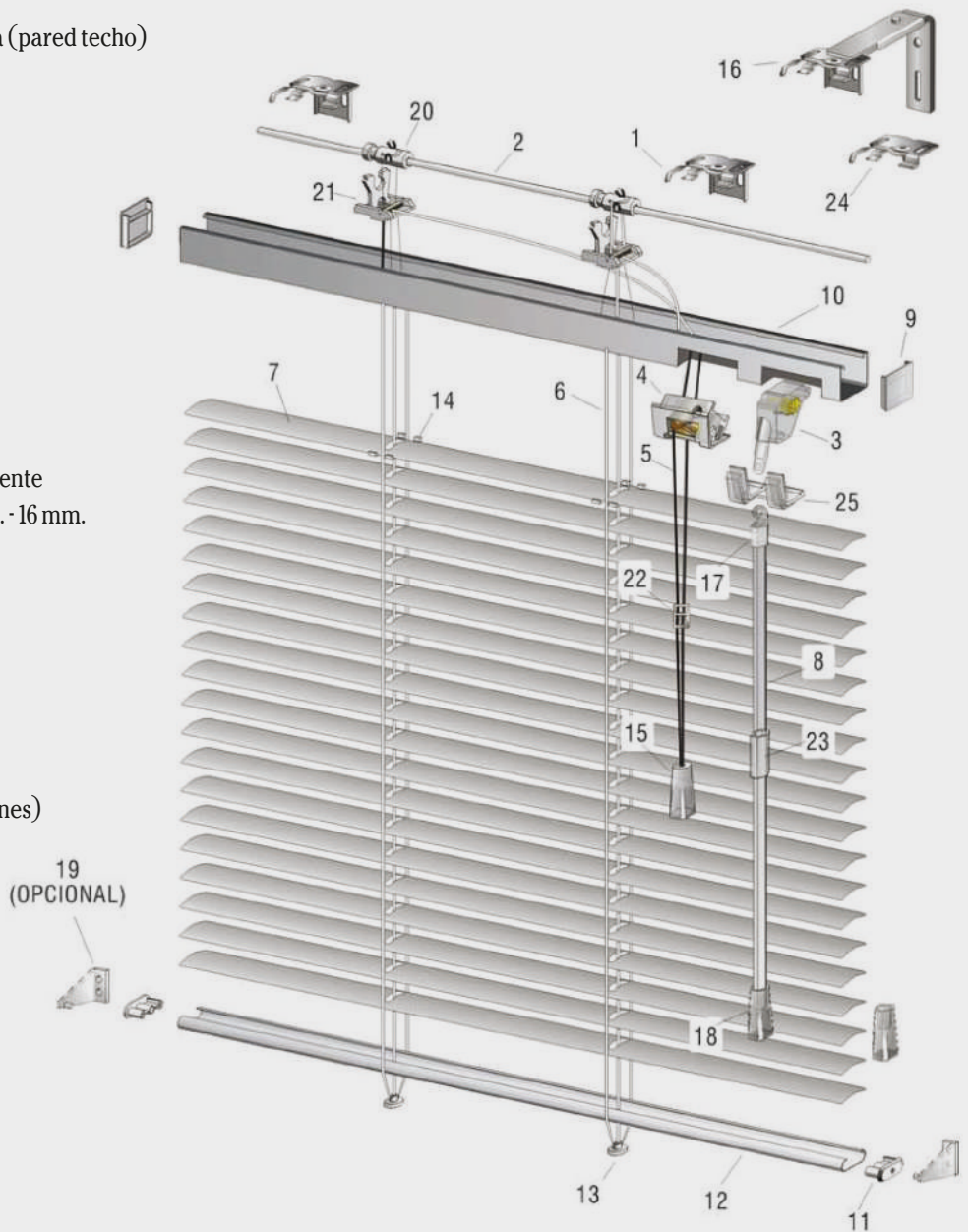

VENECIANAS MOSQUITERAS

- 1- 11401021 Soporte Palomita con escuadra (pared techo)
- 2- 11209001 Varilla de hierro media luna
- 3- 11401010 Maquinilla de graduar
- 4- 11401011 Maquinilla de freno
- 5- 11216 Cordón 1,4 mm.
- 6- 11214- 15 Escalerilla 25 mm. - 16 mm.
- 7- 11601 Lama
- 8- 11401 Varilla PVC
- 9- 11401012 Tope cabezal transparente
- 10- 11201 Cabezal
- 11- 11401013 Tope riel transparente
- 12- 11202 Riel
- 13- 11401014 Botón final escalerilla transparente
- 14- 11401025 Sujeción primera lama 25 mm. - 16 mm.
- 15- 11401015 Tirador de cordón
- 16- 11420001 Soporte extensible 60 mm.
- 17- 11401007 Gancho unión varilla
- 18- 11401016 Tirador de varilla PVC
- 19- 11401023 Cogida de riel
- 20- 11401009 Bombo sin tornillo
- 21- 11401022 Soporte bombo
- 22- 11401026 Corrector cordón (con 4 cordones)
- 23- 11401028 Conector de varilla
- 24- 11401018 Soporte techo
- 25- 11401019 Embellecedor de graduar



GUIADA CABLE

- Kit preparado para altura de persiana 2.500 mm.

Código:
30699030

Galerías Álvarez se reserva el derecho de modificar o innovar el diseño de las piezas sin previo aviso.

VENECIANAS 25 mm

DESCRIPCIÓN	PRECIO
COLOR LISO	Mínimo Facturación: 1,00 m2
MADERA	Mínimo Facturación: 1,50 m2
PERFORADA	Mínimo Facturación: 1,50 m2
INDEFORMABLE (PVC)	Mínimo Facturación: 1,50 m2

Facturación mínima 1m² para COLOR LISO y 1,50m² para el resto de COLORES Y COMBINADAS
Se facturará en múltiplos de 5 cms.

VENECIANAS 16 mm

DESCRIPCIÓN	PRECIO
COLOR LISO	Mínimo Facturación: 1,00 m2

Facturación mínima 1m² para COLOR LISO.
Se facturará en múltiplos de 5 cms.

OPCIONES SISTEMAS

DESCRIPCIÓN	PRECIO
KIT GUÍA CABLE (2500 mm)	
MOTORIZACIÓN CABEZAL 25 mm PULSADOR	BAJO PRESUPUESTO
MOTORIZACIÓN CABEZAL 25 mm VÍA RADIO	BAJO PRESUPUESTO
MANDO 1 CANAL	BAJO PRESUPUESTO
MANDO 4 CANALES	BAJO PRESUPUESTO

SOPORTES

DESCRIPCIÓN	PRECIO
SOPORTE EXTENSIBLE 60 mm	
SOPORTE EXTENSIBLE 120 mm	
SOPORTE TECHO VENECIANA	
SOPORTE PALOMITA CON ESCUADRA	
COGIDA DE RIEL	

Nota: Todas las venecianas se sirven con soporte palomita (pared-techo),

OTRAS OPCIONES

DESCRIPCIÓN	PRECIO
VENECIANA INFERIOR A 350 mm	
TRABAJO ESPECIAL	
COMBINACIÓN DE COLORES	

MEDIDAS DE OCUPACIÓN

Recogida en mm.

Altos en mm.	25 mm.	16 mm.
1.000	60	70
1.200	65	77
1.400	70	85
1.600	75	93
1.800	80	110
2.000	85	107
2.200	90	115
2.400	95	125
2.600	100	130
2.800	110	135
3.000	115	140

Nº CORDÓN Y ESCALERILLA

	Altos en mm.	Escalerilla	Cordón
25 mm.	100 - 749	2	2
	750 - 1.299	3	3
	1.300 - 1.799	4	4
	1.800 - 2.299	5	4
	2.300 - 3.000	6	4
16 mm.	79 - 649	2	2
	650 - 1.099	3	3
	1.100 - 1.499	4	4
	1.500 - 1.799	5	4
	1.800 - 3.000	6	4

Nº SOPORTES

Altos en mm.	Nº Soportes
0 - 1.299	2
1.300 - 1.999	3
2.000 - 2.599	4
2.600 - 3.000	5

OPCIONES DE MANDOS SEGÚN MEDIDAS

Altos en mm.	
90 - 199	Sin mandos
200 - 259	Un mando*
260 - 309	Normales**
310 - 3.000	Izquierda / Derecha / Normales

Altos en mm.	GUÍADAS
200 - 249	Sin mandos
250 - 309	Un mando*
310 - 359	Normales**
360 - 3.000	Izquierda / Derecha / Normales

Altos en mm.	ALTURA MANDOS
0 - 199	1.000
200 - 300	1.500

* Se puede poner el mecanismo de graduar o el freno de subida y bajada.

EN ESTE TIPO DE PERSIANAS LAS LAMAS TIENDEN A INCLINARSE HACIA EL LADO DEL MECANISMO

** La varilla de PVC al lado izquierdo y el cordón de subida y bajada a la derecha.

INCLINACIÓN: 25° respecto a la vertical con sistema de guía cable.

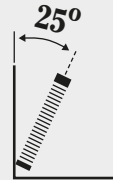

INSTRUCCIONES DE MEDIDAS:

- HUECO:**
- Alto del hueco menos 5 mm.
 - Ancho del hueco menos 5 mm.
 - Tomar dos o tres medidas de referencia tanto en ancho como en altura y coger la medida más pequeña.
- PARCHE:**
- Alto total de medida de persiana.
 - Ancho total de medida de persiana.



MEDIDAS MÁXIMAS Y MÍNIMAS. m² MÁXIMO

	25 / 16 mm.
m²	3,5 m² (aconsejable)
ALTO MÁXIMO	3.000 mm. (aconsejable)
ANCHO MÁXIMO	2.800 mm. (aconsejable)
ANCHO MÍNIMO	Standard 350 mm. Monomandos 500 mm. Para medidas inferiores ver sección trabajos especiales. Monomandos 500 mm. Consultar OPCIONES DE MANDOS.

MEDIDAS DE TERMINACIÓN:

ALTURA TOTAL: Dependiendo de la escalerilla tiene una variación de +/- 20 mm.
ANCHO TOTAL: Variación de +/- 2,5 cm.

DISTANCIA PRIMERA ESCALERILLA (ESTÁNDAR)

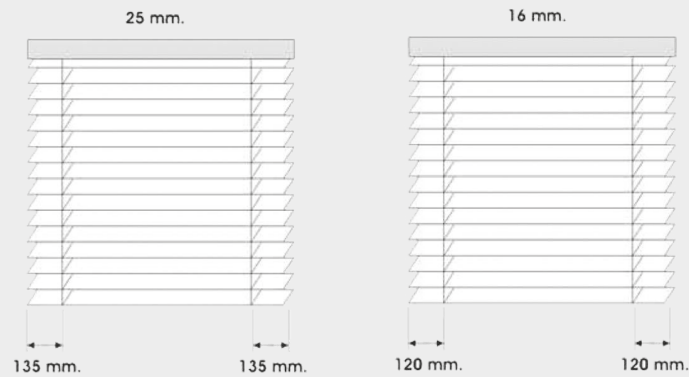

CARACTERÍSTICAS GENERALES:

CABEZAL: Medidas de 25 x 24 mm. Para 25 - 16 mm. Cantos en forma de "U" de espesor 0,5 mm. De hierro FEP01 con acabado fosfatado por inmersión en agua desmineralizada con máximo de 10 microsiemens y pintado en dos capas, primera de vinilo y posteriormente una capa de polvo de poliéster lacado al horno infrarrojo a temperatura de 230° de un grosor de 14-21 micrones s/color.

RIEL: Medida de 16 mm. en forma de "C" invertida para 25 - 16 mm. cerrado de 50 mm. De las mismas características que el cabezal.

LAMA: Constituida por aluminio virgen con óptima aleación que permita la máxima fuerza, flexibilidad y resistencia a los factores de corrosión tanto externos como internos.

Medida en anchura 25 mm. Espesor 0,21 mm.
Medida de anchura 16 mm. Espesor 0,21 mm.

Imprimación con polvo de poliéster y proceso electrostático con secado al horno por infrarrojo.

CORDÓN: Cordón de 1,4 mm. y 3 mm. 100% poliéster. El cordón es de la misma tonalidad que las lamas de la persiana.

ACCIONAMIENTOS: Por mecanismos de elevación y orientación fabricados con A.B.S. fortalecido e hierro cincado.

Cantoneras de cabezal y riel de color transparente.

LUGARES DE INSTALACIÓN:

Su línea y diversidad de colores se adapta a lugares como oficina, hogar, escaparates...
NO SE RECOMIENDA instalar en lugares húmedos (ej. baños, piscinas climatizadas...) o exteriores debido a la oxidación.



VENECIANAS DE MADERA

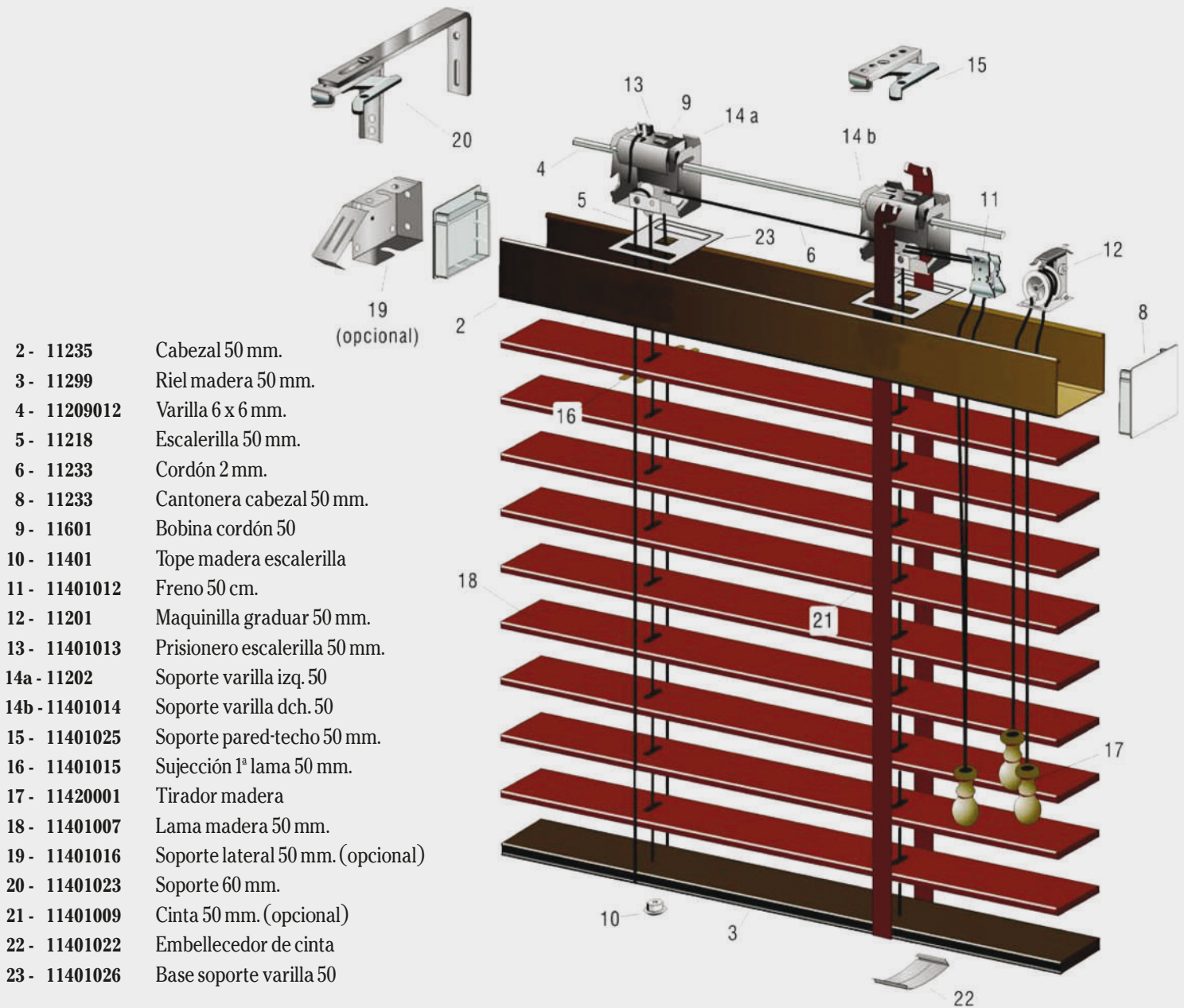

PERSIANA CON ESCALERILLA



PERSIANA CON CINTA



CATÁLOGO PERSIANA DE MADERA 18 €/NETO

PRECIOS VENECIANA MADERA MODELO COLONIAL 25 / 35 mm.

VENECIANA MADERA 25 mm. COLONIAL CON ESCALERILLA (CABEZAL 31 x 37)							
ANCHO PVP							
	0,60	0,80	1,00	1,20	1,40	1,60	1,80
ALTO	0,75						
	1,00						
	1,25						
	1,50						
	1,75						
	2,00						
	2,25						
	2,50						

VENECIANA MADERA 25 mm. COLONIAL CON CINTA 25 mm. (CABEZAL 25 x 25)							
ANCHO PVP							
	0,60	0,80	1,00	1,20	1,40	1,60	1,80
ALTO	0,75						
	1,00						
	1,25						
	1,50						
	1,75						
	2,00						
	2,25						
	2,50						

VENECIANA MADERA 35 mm. CON ESCALERILLA (CABEZAL 25 x 25)								
ANCHO PVP								
	0,60	0,80	1,00	1,20	1,40	1,60	1,80	2,00
ALTO	0,75							
	1,00							
	1,25							
	1,50							
	1,75							
	2,00							
	2,25							
	2,50							
	2,75							
	3,00							

VENECIANA MADERA 35 mm. CON CINTA 16 mm. (CABEZAL 31 x 37)								
ANCHO PVP								
	0,60	0,80	1,00	1,20	1,40	1,60	1,80	2,00
ALTO	0,75							
	1,00							
	1,25							
	1,50							
	1,75							
	2,00							
	2,25							
	2,50							
	2,75							
	3,00							

LAMA 35 mm.			
MODELO	ESCALERILLA	CINTA 25 / 38 mm.	MÍNIMO A FACTURAR
HIGHGLOSS			1,50 m2
HIGHTECH			1,50 m2

PRECIOS VENECIANA MADERA MODELO COLONIAL 50 mm.

VENECIANA MADERA 50 mm. CON ESCALERILLA (CABEZAL 51 x 57)

		ANCHO PVP												
		0,60	0,80	1,00	1,20	1,40	1,60	1,80	2,00	2,20	2,40	2,60	2,80	3,00
ALTO	0,75													
	1,00													
	1,25													
	1,50													
	1,75													
	2,00													
	2,25													
	2,50													
	2,75													
	3,00													

VENECIANA MADERA 50 mm. CON CINTA 10 mm. Y CINTA 25 mm. (CABEZAL 51 x 57)

		ANCHO PVP												
		0,60	0,80	1,00	1,20	1,40	1,60	1,80	2,00	2,20	2,40	2,60	2,80	3,00
ALTO	0,75													
	1,00													
	1,25													
	1,50													
	1,75													
	2,00													
	2,25													
	2,50													
	2,75													
	3,00													

VENECIANA MADERA 50 mm. CON CINTA 38 mm. (CABEZAL 51 x 57)

		ANCHO PVP												
		0,60	0,80	1,00	1,20	1,40	1,60	1,80	2,00	2,20	2,40	2,60	2,80	3,00
ALTO	0,75													
	1,00													
	1,25													
	1,50													
	1,75													
	2,00													
	2,25													
	2,50													
	2,75													
	3,00													

LAMA 50 mm.

MODELO	ESCALERILLA	CINTA 25 / 38 mm.	MÍNIMO A FACTURAR
HIGHGLOSS			1,50 m2
BURO/RAL			1,50 m2
HIGHTECH			1,50 m2

PRECIOS VENECIANA MADERA MODELO COLONIAL 70 mm.

VENECIANA MADERA 70 mm. CON ESCALERILLA (CABEZAL 51 x 57)														
ANCHO PVP														
	0,60	0,80	1,00	1,20	1,40	1,60	1,80	2,00	2,20	2,40	2,60	2,80	3,00	
ALTO	0,75													
	1,00													
	1,25													
	1,50													
	1,75													
	2,00													
	2,25													
	2,50													
	2,75													
	3,00													

VENECIANA MADERA 70 mm. CON CINTA 10 mm. Y CINTA 38 mm. (CABEZAL 51 x 57)														
ANCHO PVP														
	0,60	0,80	1,00	1,20	1,40	1,60	1,80	2,00	2,20	2,40	2,60	2,80	3,00	
ALTO	0,75													
	1,00													
	1,25													
	1,50													
	1,75													
	2,00													
	2,25													
	2,50													
	2,75													
	3,00													

LAMA 70 mm.			
MODELO	ESCALERILLA	CINTA 25 / 38 mm.	MÍNIMO A FACTURAR
HIGHGLOSS			1,50 m2
BURO			1,50 m2
HIGHTECH			1,50 m2

LAMA 25 mm.

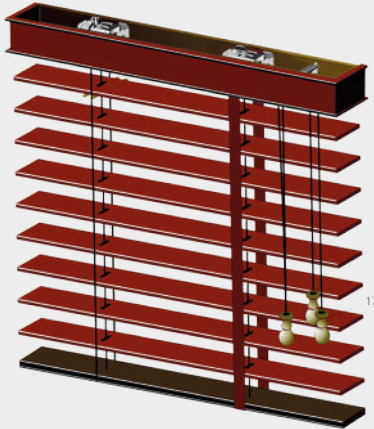

LAMA 35 mm.



LAMA 50 mm.



LAMA 25 mm.

Medida ancho de lama: 27+ 0.08 mm.

Grosor de lama: 3+ 0.01 mm.

Alabeo de lama: 1.4 m+ 2.5 mm.

Tipo de Madera: Abachiwood

Cenefa: Incluye una cenefa de madera a tono con el color de la lama, sujeta al cabezal con imanes.

Peso cortina: 1.8 kg / m²

Ancho mínimo: 300 mm.

Ancho máximo: 1.400 mm.

Alto mínimo: 300 mm.

Alto máximo: 2.500 mm.

SISTEMA OPERACIÓN MANUAL

Medida Cabezal:

Escalerilla: 29 x 30 mm.

Cinta: 37 x 37 mm.

Tipo de cordón: A juego con el color de la sujección.

Tipo de Soporte

Escalerilla: Soporte giratorio

Cinta: Cajetines Laterales

Operación: Mediante cordones para orientar, subir y bajar la cortina

Altura cortina	Repliegue	
	Escalerilla	Cinta
600 mm	147 mm	153 mm
1.000 mm	206 mm	224 mm
1.500 mm	287 mm	312 mm
2.000 mm	367 mm	400 mm
2.500 mm	447 mm	488 mm
3.000 mm		576 mm

Las medidas de repliegue son aproximadas

LAMA 35 mm.

Medida ancho de lama: 35+ 0.08 mm.

Grosor de lama: 3+ 0.01 mm.

Alabeo de lama: 2 m+ 3.5 mm.

Tipo de Madera: Abachiwood

Cenefa: Incluye una cenefa de madera a tono con el color de la lama, sujeta al cabezal con imanes.

Peso cortina: 2.0 kg / m²

Ancho mínimo: 300 mm.

Ancho máximo: 2.000 mm.

Alto mínimo: 300 mm.

Alto máximo: 2.500 mm.

SISTEMA OPERACIÓN MANUAL

ESCALERILLA / CINTA

Medida Cabezal: 37 x 37 mm

Tipo de cordón: A juego con el color de la sujección.

Tipo de sujección: Cajetines Laterales

Opcional soporte giratorio a techo y pared o escuadras de 100/150 y 150/200 mm.

Operación: Mediante cordones para orientar, subir y bajar la cortina

Altura cortina	Repliegue	
	Escalerilla	Cinta
600 mm	120 mm	141 mm
1.000 mm	163 mm	186 mm
1.500 mm	218 mm	254 mm
2.000 mm	278 mm	322 mm
2.500 mm	329 mm	390 mm
3.000 mm	384 mm	458 mm

Las medidas de repliegue son aproximadas

LAMA 50 mm.

Medida ancho de lama: 50+ 0.08 mm.

Grosor de lama: 3+ 0.01 mm.

Alabeo de lama: 3 m+ 3 mm.

Tipo de Madera: Abachiwood

Cenefa: Incluye una cenefa de madera a tono con el color de la lama, sujeta al cabezal con imanes.

Peso cortina: 2.1 kg / m² (Except Hightech)

Ancho mínimo: 300 mm.

Ancho máximo: 3.000 mm.

Alto mínimo: 300 mm.

Alto máximo: 3.500 mm.

SISTEMA OPERACIÓN MANUAL

ESCALERILLA / CINTA

Medida Cabezal: 51 x 57 mm

Tipo de cordón: A juego con el color de la sujección.

Tipo de sujección: Cajetines Laterales

Opcional soporte giratorio a techo y pared o escuadras de 100/150 y 150/200 mm.

Operación: Mediante cordones para orientar, subir y bajar la cortina

Altura cortina	Repliegue		
	Escalerilla	Cinta 25	Cinta 38
600 mm	124 mm	134 mm	131 mm
1.000 mm	159 mm	173 mm	172 mm
1.500 mm	202 mm	221 mm	223 mm
2.000 mm	245 mm	269 mm	276 mm
2.500 mm	288 mm	317 mm	325 mm
3.000 mm	331 mm	365 mm	376 mm

Las medidas de repliegue son aproximadas

MOSQUITERA ENROLLABLE VERTICAL



mosquitera
L-2005
ENROLLABLE

 Ideal para instalar en ventanas

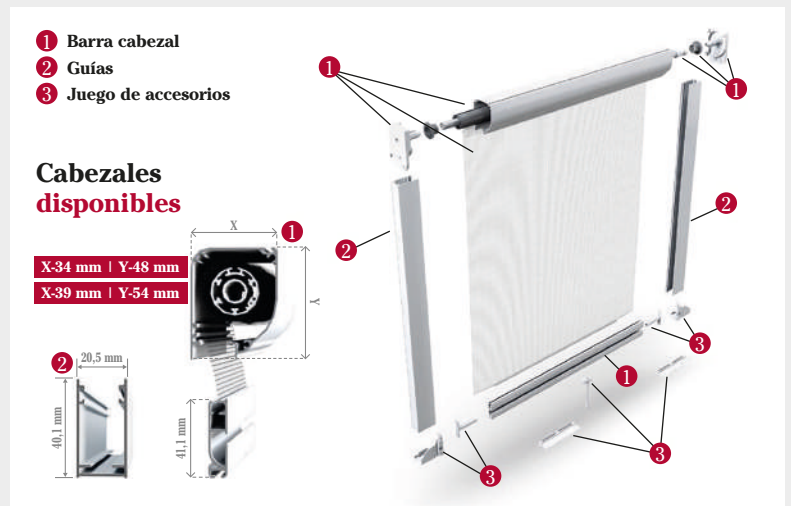

OPCIONES

Sistema
**Reductor de
velocidad RDS**



OPCIONES INSTALACIÓN



Soporte de
Anclaje frontal



Sistema de
anclaje mediante
Soporte clip



Ideal para instalación en ventanas.

Medidas máximas: **Alto máx.: 2200 mm Ancho máx.: 1600 mm Ancho min.: 640 mm**

Ancho máximo recomendado 1600 mm. No se garantiza su correcto funcionamiento a mayor medida.

Disponibles confeccionadas en 35 y 39. Salvo frontal y BlackOut.

Cabezal 35 mm. máximo 1400 mm de alto.

LACADO BLANCO / ANOD. PLATA

ANCHO	0,60	0,70	0,80	0,90	1,00	1,10	1,20	1,30	1,40	1,50	1,60
ALTO 0,60											
0,70											
0,80											
0,90											
1,00											
1,10											
1,20											
1,30											
1,40											
1,50											
1,60											
1,70											
1,80											
1,90											
2,00											
2,10											
2,20											



OPCIONES

SISTEMA MUELLE RDS (disponible para anchos de entre 640 Y 1400 mm.)

INCREMENTO SOPORTE MOSQUITERA CLIP

INCREMENTO SOPORTE MOSQUITERA FRONTAL

MOSQUITERA ENROLLABLE VERTICAL

RAL ESTÁNDAR / LACADO BRONCE - INOX - PLATA

ANCHO	0,60	0,70	0,80	0,90	1,00	1,10	1,20	1,30	1,40	1,50	1,60
ALTO	0,60										
	0,70										
	0,80										
	0,90										
	1,00										
	1,10										
	1,20										
	1,30										
	1,40										
	1,50										
	1,60										
	1,70										
	1,80										
	1,90										
	2,00										
2,10											
2,20											



ANOD. BRONCE - INOX

ANCHO	0,60	0,70	0,80	0,90	1,00	1,10	1,20	1,30	1,40	1,50	1,60
ALTO	0,60										
	0,70										
	0,80										
	0,90										
	1,00										
	1,10										
	1,20										
	1,30										
	1,40										
	1,50										
	1,60										
	1,70										
	1,80										
	1,90										
	2,00										
2,10											
2,20											



MADERA

ANCHO	0,60	0,70	0,80	0,90	1,00	1,10	1,20	1,30	1,40	1,50	1,60
ALTO	0,60										
	0,70										
	0,80										
	0,90										
	1,00										
	1,10										
	1,20										
	1,30										
	1,40										
	1,50										
	1,60										
	1,70										
	1,80										
	1,90										
	2,00										
2,10											
2,20											



OPCIONES

SISTEMA MUELLE RDS (disponible para anchos de entre 640 Y 1400 mm.)

INCREMENTO SOPORTE MOSQUITERA CLIP

INCREMENTO SOPORTE MOSQUITERA FRONTAL

MOSQUITERA ENROLLABLE DOBLE VERTICAL

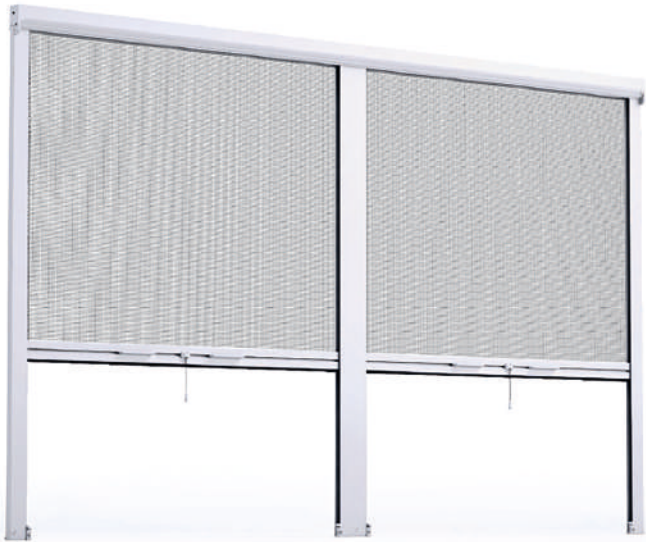

mosquitera DOBLE L-2005 ENROLLABLE

I Ideal para instalar en ventanas

- 1 Barra cabezal
- 2 Perfil guías
- 3 Juego de accesorios
- 4 Perfil guía doble

Cabezales disponibles

X-34 mm | Y-48 mm

X-39 mm | Y-54 mm

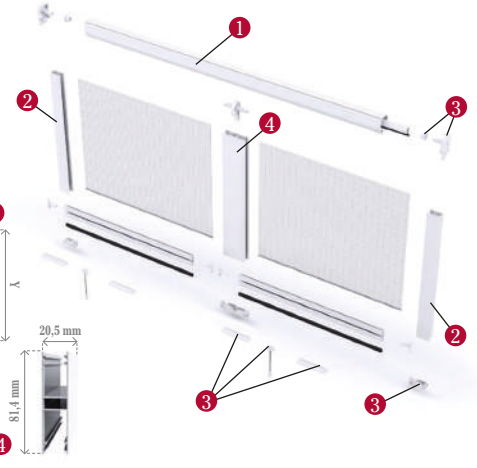
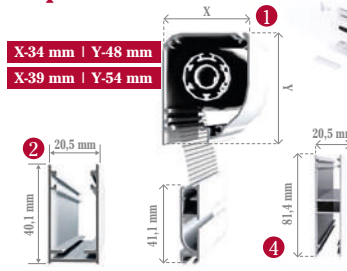

OPCIONES

Pieza Unión doble



OPCIONES INSTALACIÓN



Soporte de Anclaje frontal



Sistema de anclaje mediante Soporte clip

Ideal para instalación en ventanas.

Medidas máximas: Alto máx.: 2200 mm Ancho máx.: 3200 mm Ancho mín.: 1280 mm

Ancho máximo recomendado 3200 mm. No se garantiza su correcto funcionamiento a mayor medida.

Disponible confeccionada en 35 y 39. Salvo frontal y BlackOut.

Cabezal 35 mm. máximo 1400 mm de alto.

LACADO BLANCO / ANOD. PLATA

ANCHO	1,20	1,40	1,60	1,80	2,00	2,20	2,40	2,60	2,80	3,00	3,20
ALTO 0,60											
0,70											
0,80											
0,90											
1,00											
1,10											
1,20											
1,30											
1,40											
1,50											
1,60											
1,70											
1,80											
1,90											
2,00											
2,10											
2,20											



OPCIONES

SISTEMA MUELLE RDS (disponible para anchos de entre 640 Y 1400 mm.)

INCREMENTO SOPORTE MOSQUITERA CLIP

INCREMENTO SOPORTE MOSQUITERA FRONTAL

MOSQUITERA ENROLLABLE DOBLE VERTICAL

RAL ESTÁNDAR / LACADO BRONCE - INOX - PLATA

		ANCHO	1,20	1,40	1,60	1,80	2,00	2,20	2,40	2,60	2,80	3,00	3,20
ALTO	0,60												
	0,70												
	0,80												
	0,90												
	1,00												
	1,10												
	1,20												
	1,30												
	1,40												
	1,50												
	1,60												
	1,70												
	1,80												
	1,90												
	2,00												
2,10													
2,20													



ANOD. BRONCE - INOX

		ANCHO	1,20	1,40	1,60	1,80	2,00	2,20	2,40	2,60	2,80	3,00	3,20
ALTO	0,60												
	0,70												
	0,80												
	0,90												
	1,00												
	1,10												
	1,20												
	1,30												
	1,40												
	1,50												
	1,60												
	1,70												
	1,80												
	1,90												
	2,00												
2,10													
2,20													



MADERA

		ANCHO	1,20	1,40	1,60	1,80	2,00	2,20	2,40	2,60	2,80	3,00	3,20
ALTO	0,60												
	0,70												
	0,80												
	0,90												
	1,00												
	1,10												
	1,20												
	1,30												
	1,40												
	1,50												
	1,60												
	1,70												
	1,80												
	1,90												
	2,00												
2,10													
2,20													



OPCIONES

SISTEMA MUELLE RDS (disponible para anchos de entre 640 Y 1400 mm.)

INCREMENTO SOPORTE MOSQUITERA CLIP

INCREMENTO SOPORTE MOSQUITERA FRONTAL

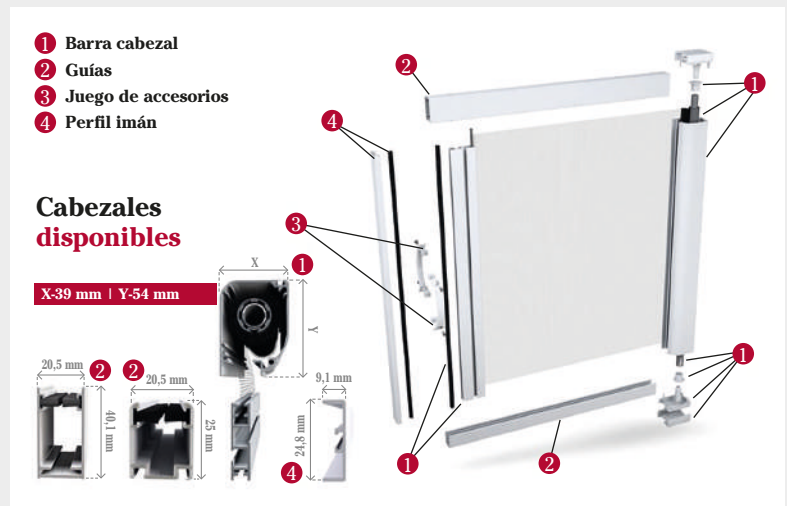

Ideal para instalación en puertas y ventanas.

39 mm Simple

Medidas máximas: Alto máx.: 2300 mm Ancho máx.: 1200 mm Ancho mín.: 610 mm

Ancho máximo recomendado 1200 mm. No se garantiza su correcto funcionamiento a mayor medida.

Disponible confeccionada en 39. Salvo BlackOut.

LACADO BLANCO / ANOD. PLATA

	ANCHO	0,60	0,70	0,80	0,90	1,00	1,10	1,20
ALTO	1,20							
	1,30							
	1,40							
	1,50							
	1,60							
	1,70							
	1,80							
	1,90							
	2,00							
	2,10							
	2,20							
2,30								



OPCIONES

INCREMENTO SOPORTE MOSQUITERA CLIP

INCREMENTO SOPORTE MOSQUITERA FRONTAL

MOSQUITERA ENROLLABLE LATERAL

RAL ESTÁNDAR / L. BRONCE - INOX - PLATA

		ANCHO	0,60	0,70	0,80	0,90	1,00	1,10	1,20
ALTO	1,20								
	1,30								
	1,40								
	1,50								
	1,60								
	1,70								
	1,80								
	1,90								
	2,00								
	2,10								
	2,20								
	2,30								



ANOD. BRONCE - INOX

		ANCHO	0,60	0,70	0,80	0,90	1,00	1,10	1,20
ALTO	1,20								
	1,30								
	1,40								
	1,50								
	1,60								
	1,70								
	1,80								
	1,90								
	2,00								
	2,10								
	2,20								
	2,30								



MADERA

		ANCHO	0,60	0,70	0,80	0,90	1,00	1,10	1,20
ALTO	1,20								
	1,30								
	1,40								
	1,50								
	1,60								
	1,70								
	1,80								
	1,90								
	2,00								
	2,10								
	2,20								
	2,30								



OPCIONES

INCREMENTO SOPORTE MOSQUITERA CLIP

INCREMENTO SOPORTE MOSQUITERA FRONTAL



Ideal para instalar en puertas y ventanas

mosquitera

LATERAL DOBLE L-2005 ENROLLABLE



Ideal para instalación en puertas y ventanas.

39 mm Doble

Medidas máximas: Alto máx.: 2300 mm Ancho máx.: 2400 mm

Ancho máximo recomendado 2400 mm. No se garantiza su correcto funcionamiento a mayor medida.

Disponible confeccionada en 39. Salvo BlackOut.

LACADO BLANCO / ANOD. PLATA

ANCHO	0,60	0,80	1,00	1,20	1,40	1,60	1,80	2,00	2,20	2,40
ALTO	1,20									
	1,30									
	1,40									
	1,50									
	1,60									
	1,70									
	1,80									
	1,90									
	2,00									
	2,10									
	2,20									
2,30										



OPCIONES

INCREMENTO SOPORTE MOSQUITERA CLIP

INCREMENTO SOPORTE MOSQUITERA FRONTAL

MOSQUITERA ENROLLABLE LATERAL DOBLE

RAL ESTÁNDAR / L. BRONCE - INOX - PLATA

ANCHO	0,60	0,80	1,00	1,20	1,40	1,60	1,80	2,00	2,20	2,40
ALTO	1,20									
	1,30									
	1,40									
	1,50									
	1,60									
	1,70									
	1,80									
	1,90									
	2,00									
	2,10									
	2,20									
	2,30									



ANOD. BRONCE - INOX

ANCHO	0,60	0,80	1,00	1,20	1,40	1,60	1,80	2,00	2,20	2,40
ALTO	1,20									
	1,30									
	1,40									
	1,50									
	1,60									
	1,70									
	1,80									
	1,90									
	2,00									
	2,10									
	2,20									
	2,30									



MADERA

ANCHO	0,60	0,80	1,00	1,20	1,40	1,60	1,80	2,00	2,20	2,40
ALTO	1,20									
	1,30									
	1,40									
	1,50									
	1,60									
	1,70									
	1,80									
	1,90									
	2,00									
	2,10									
	2,20									
	2,30									



OPCIONES

INCREMENTO SOPORTE MOSQUITERA CLIP

INCREMENTO SOPORTE MOSQUITERA FRONTAL

MOSQUITERA PLSSET - PLISADA CON CADENA

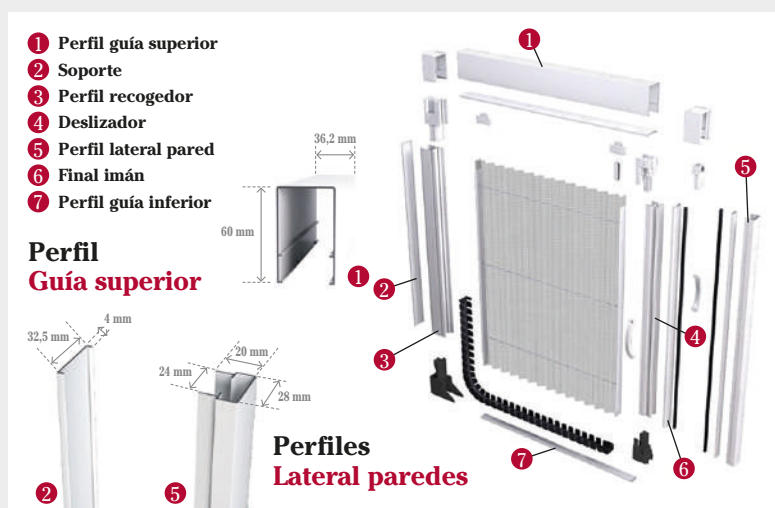

Ideal para instalación en puertas y balcones.
Medidas máximas: Alto máx.: 2500 mm Ancho máx.: 1500 mm Ancho mín.: 800 mm
El alto siempre debe superar como mínimo 200 mm el ancho.
El color blanco utilizado para este producto es el RAL 9010.

LACADO BLANCO

ANCHO	0,80	0,90	1,00	1,10	1,20	1,30	1,40	1,50
ALTO	1,45							
	1,60							
	1,75							
	1,90							
	2,05							
	2,20							
	2,35							
	2,50							



RAL ESTÁNDAR / LACADO BRONCE - PLATA - INOX

ANCHO	0,80	0,90	1,00	1,10	1,20	1,30	1,40	1,50
ALTO	1,45							
	1,60							
	1,75							
	1,90							
	2,05							
	2,20							
	2,35							
	2,50							



MADERA

ANCHO	0,80	0,90	1,00	1,10	1,20	1,30	1,40	1,50
ALTO	1,45							
	1,60							
	1,75							
	1,90							
	2,05							
	2,20							
	2,35							
	2,50							



MOSQUITERA PLSSET DOBLE - PLSADA CON CADENA DOBLE

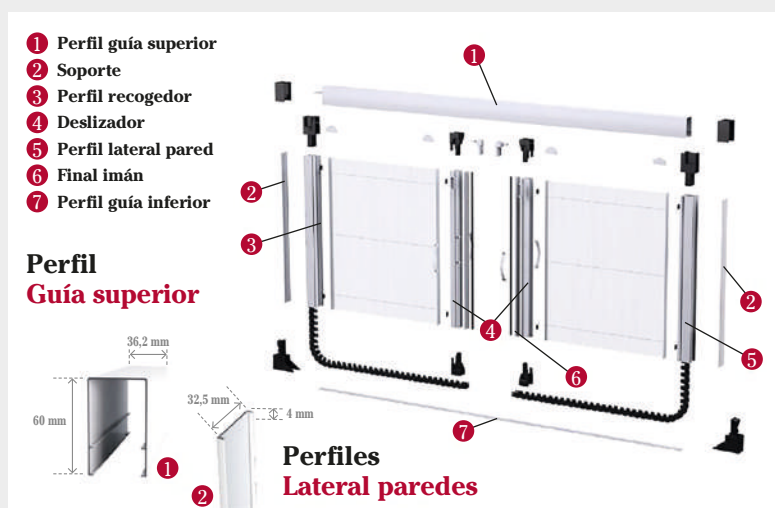

Ideal para instalación en puertas y balcones.
 Medidas máximas: **Alto máx.: 2500 mm Ancho máx.: 3000 mm Ancho mín.: 1300 mm**
 El alto siempre debe superar como mínimo 200 mm el ancho.
 El color blanco utilizado para este producto es el RAL 9010.

LACADO BLANCO

ANCHO	1,40	1,60	1,80	2,00	2,20	2,40	2,60	2,80	3,00
ALTO	1,45								
	1,60								
	1,75								
	1,90								
	2,05								
	2,20								
	2,35								
	2,50								



RAL ESTÁNDAR / LACADO BRONCE - PLATA - INOX

ANCHO	1,40	1,60	1,80	2,00	2,20	2,40	2,60	2,80	3,00
ALTO	1,45								
	1,60								
	1,75								
	1,90								
	2,05								
	2,20								
	2,35								
	2,50								



MADERA

ANCHO	1,40	1,60	1,80	2,00	2,20	2,40	2,60	2,80	3,00
ALTO	1,45								
	1,60								
	1,75								
	1,90								
	2,05								
	2,20								
	2,35								
	2,50								



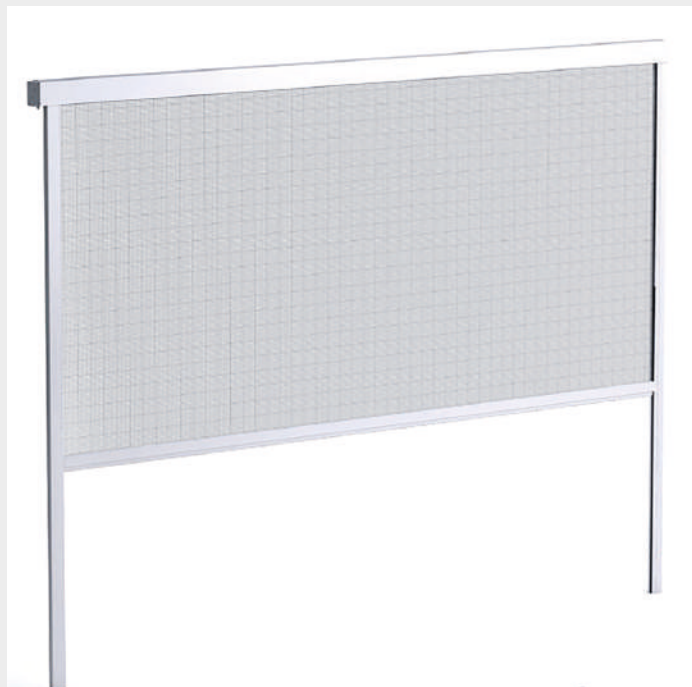

mosquitera QATIF LITE ENROLLABLE

 Ideal para grandes espacios

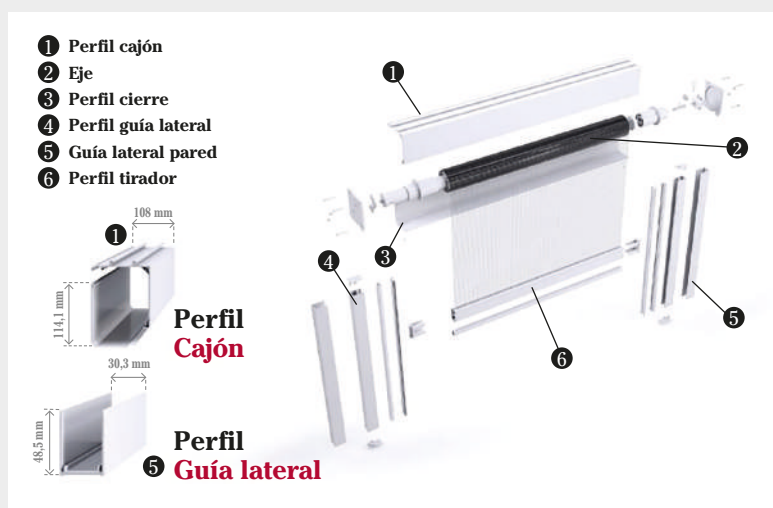

Sistema ZIP

El sistema de cremallera o zip, soldada en los laterales, aporta resistencia a las ráfagas de viento. Tejido Soltis horizon 86.



Sistema de motorización

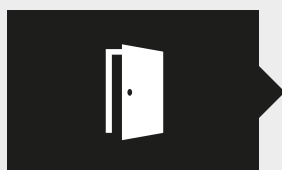

Ideal para grandes espacios.

Medidas máximas: **Alto máx.:** 3500 mm **Ancho máx.:** 5000 mm **Ancho mín.:** 1000 mm

Este producto solo podrá ser instalado lateralmente o al techo (con soportes o perfil travesaño).

Se debe especificar al solicitar el pedido.

LACADO BLANCO

ANCHO	1,50	2,00	2,50	3,00	3,50	4,00	4,50	5,00
ALTO	1,50							
	2,00							
	2,50							
	3,00							
	3,50							



RAL ESTÁNDAR

ANCHO	1,50	2,00	2,50	3,00	3,50	4,00	4,50	5,00
ALTO	1,50							
	2,00							
	2,50							
	3,00							
	3,50							



MADERA

ANCHO	1,50	2,00	2,50	3,00	3,50	4,00	4,50	5,00
ALTO	1,50							
	2,00							
	2,50							
	3,00							
	3,50							



OPCIONES

INCREMENTO MOTORIZACION QATIF LITE MOSQUITERA

MANDO 1 CANAL

MANDO 7 CANALES

MOSQUITERA NOCHE / DÍA (CON TEJIDO BLACK-OUT)

- 1 10114 Barra central 45 lateral doble L-2005
- 2 10130 Guía 40 L-2005, c/felpudo 48x8
- 3 10160 Muelle conf. izq. 4,5L-2005
- 4 10162 Conjunto cuerda L-2005
- 5 10214 Tapa tirador lateral
- 6 10218 Asa mosquitera
- 7 10377 Tapa carcasa 45 dcha. L-2005
- 8 10392999 Casquillo eje 45 L-2005
- 9 122 Tejido Black-out
- 10 10230060 Sistema RDS 45 (opcional)
- 11 10230013 Espiche de pared
- 12 10230011 Tornillo 4x40

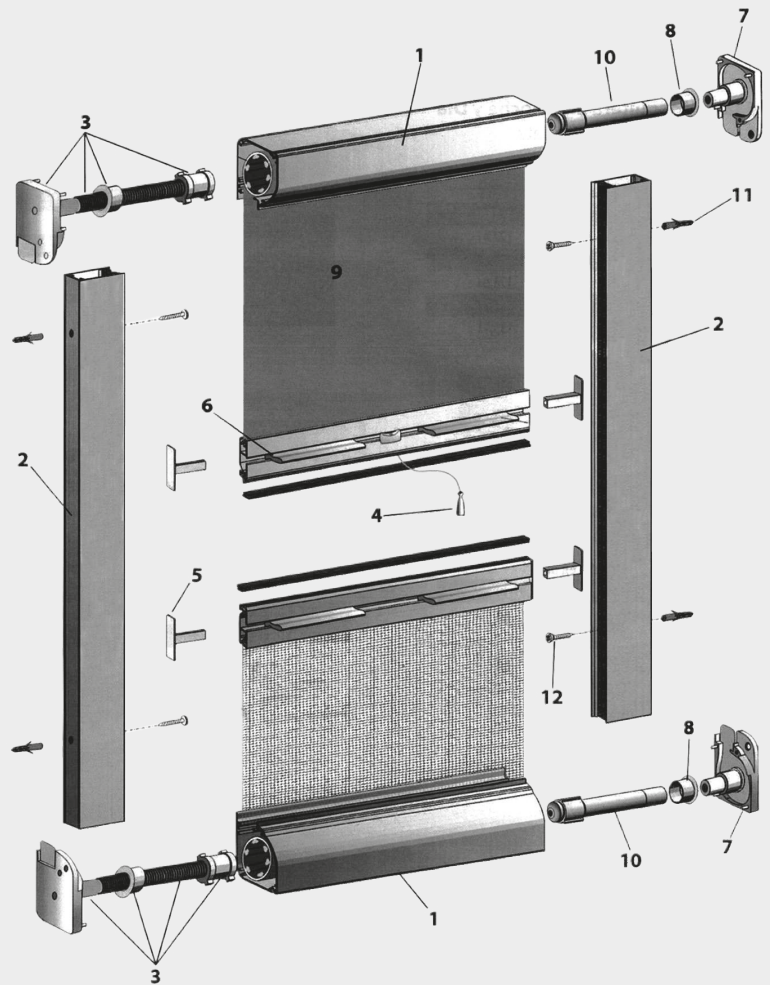

Doble función, muy práctica y cómoda, ya que permite controlar la luz y proteger de la entrada de insectos.

Están compuestas por dos cabezales enrollables con distintos tejidos, uno es una malla de mosquitera y otro un estor enrollable.

Permite elegir la opción de mosquitera, disfrutando de la luz, o filtrar la luz exterior de forma decorativa mediante el despliegue de su estor enrollable.

Integración funcional

Sistema de despliegue mediante tirador y cuerda tirador

BLANCO / ANODIZADO PLATA		
ANCHO		
1,00 1,10		
ALTO	1,00	
	1,10	
	1,20	
	1,30	
	1,40	

RAL SEMIESTANDAR / ANODIZADO BRONCE INOX		
ANCHO		
1,00 1,10		
ALTO	1,00	
	1,10	
	1,20	
	1,30	
	1,40	

MADERA		
ANCHO		
1,00 1,10		
ALTO	1,00	
	1,10	
	1,20	
	1,30	
	1,40	

RAL ESTANDAR / LACADO BRONCE INOX		
ANCHO		
1,00 1,10		
ALTO	1,00	
	1,10	
	1,20	
	1,30	
	1,40	

LACADOS Y ANODIZADOS



Inox



Plata



Bronce

RALES ESTÁNDAR

Ral 1015
Marfil Claro

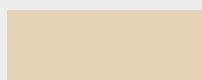

Ral 6005
Verde Musgo



Ral 6009
Verde Abeto

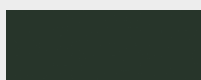

Ral 7011
Gris Hierro



Ral 7016
Gris Antracita

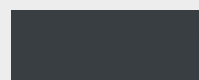

Ral 7022
Gris Sombra



Ral 3005
Rojo Vino



Ral 3007
Rojo Negruzco



Ral 8014
Marrón Sepia



Ral 8017
Chocolate



Ral 8019
Pardo Grisáceo



Ral 9011
Negro Grafito



LACADOS MADERA

Clara

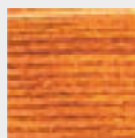

Oscura

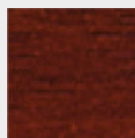

Pino Medio

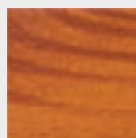

Teka Oscuro

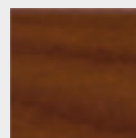

Nogal Oscuro

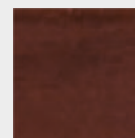

Sapelli

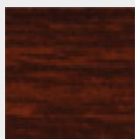

Embero Rugoso

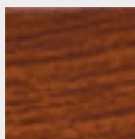

Imitación Roble

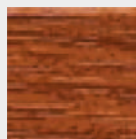

Imitación Nogal

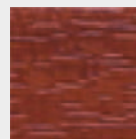

Nogal Andaluz

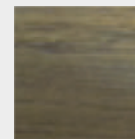

Otros colores bajo presupuesto